

# **TELAIRE<sup>®</sup>**

## **Air Quality Sensors**

Particle Matter, CO<sub>2</sub>, Humidity,  
Temperature and Dust Products

OEM Sensor Components for Air Quality  
and Environmental Control





## Overview

Telaire products have been at the forefront of Carbon Dioxide sensing technology for the last 25 years and are the originators of the maintenance free CO<sub>2</sub> Non Dispersive Infrared (NDIR) sensor. Telaire has over 35 patents around its technology including ABC logic that warrants calibration for the life of the sensor. Telaire products are designed with pride in Santa Barbara, California.

Telaire OEM components are used extensively in heating and ventilation control and Industrial applications.

### Typical applications include:

- Commercial building Demand Control Ventilation (DCV)
- Commercial building energy conservation and air quality control
- Demand Based Sensing for residential heat exchangers (DCV)
- Core technology of HVAC transmitters
- Sensing in refrigerated storage/shipping containers
- Indoor growing CO<sub>2</sub> control
- Agricultural livestock housing ventilation control
- Air purifier control & monitoring
- Automotive in cabin air quality and safety
- Liquid Fuel based residential heating safety
- Handheld CO<sub>2</sub> and IAQ instruments
- CO<sub>2</sub> Leak Detection
- Frost monitoring for small ventilation units
- Occupancy detection for wall mounted heaters
- Gas sensing in Incubators

# CO<sub>2</sub> Modules for OEM Integration

## Module Selection - Single or Dual Channel?

### Single & Dual Wavelength Use in Practise

The difference between single and dual wavelength CO<sub>2</sub> sensing is the way sensor drift is controlled, Telaire are the only manufacturer that has both technologies within their portfolio. Factory calibration and interfaces are generally the same.

Single wavelength continuously monitors the environment and records the lowest values, it then makes any necessary correction to the calibration based on these low values. This is Telaire's patented ABC Logic algorithm. Where applicable it is the most stable methodology to control long term drift. Single wavelength should only be used where the environment periodically drops to ambient (~ 400ppm) CO<sub>2</sub> levels

Dual wavelength does a continuous comparison with a reference wavelength within the sensor and makes any necessary adjustment accordingly. Whilst not as accurate as the ABC Logic long term, it does offer stability in environments where the natural lows are not registered. Therefore it is important to use Dual wavelength in any application where the environment does not periodically drop to ambient (~ 400ppm) CO<sub>2</sub> levels.

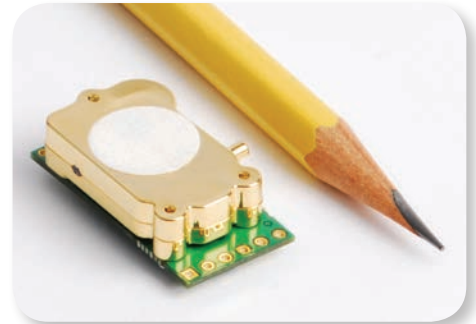

	Single Wavelength	Dual Wavelength
Telaire Part Numbers	T6613-X Sensor Modules T6713-X Sensor Modules	T6615-X Sensor Modules T6715-X Sensor Module
Typical Use	<ul style="list-style-type: none"> <li>Commercial Office Monitoring</li> <li>Residential monitoring</li> <li>Cinema</li> <li>Exhibition Hall</li> <li>Automotive sensing</li> <li>Railway car monitoring</li> </ul>	<ul style="list-style-type: none"> <li>24/7 Security suite</li> <li>Agricultural applications (Indoor growing, green/glass house, pig shed)</li> <li>Hospitals</li> <li>Food monitoring &amp; storage</li> <li>Metering</li> </ul>

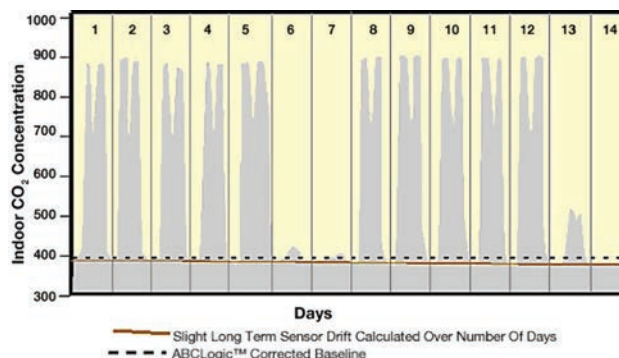

# Miniature CO<sub>2</sub> Modules for OEM Integration

## T6700 Series

The new T6700 Series is a miniature NDIR CO<sub>2</sub> sensor that has accuracy and reliability of many larger sensors. The new small size allows OEM's to integrate into smaller enclosures and equipment and uses significantly less power than many other devices on the market.

Three model families are available:

### T6713

The Telaire® T6713 CO<sub>2</sub> Series is ideal for applications where CO<sub>2</sub> levels need to be measured and controlled for indoor air quality and energy saving applications such as demand control ventilation.

All units are factory calibrated to measure CO<sub>2</sub> concentration levels up to 5000ppm.

### T6703

The Telaire T6703 CO<sub>2</sub> Module is configured for applications where CO<sub>2</sub> levels are less critical, but an assessment of indoor air quality is required, for example in residential applications. Our minimum order requirement reflects the high volumes of these applications.

All units are factory calibrated to measure CO<sub>2</sub> concentration levels up to 5000ppm, while maintaining accuracy across the range.

### T6715

The new T6715 is the smallest most accurate dual channel CO<sub>2</sub> sensor available on the market today. Telaire dual channel technology allow self calibration in applications where ABC logic will not work. i.e. Buildings with full time occupancy, instrumentation and agricultural applications.

## Features

- An affordable gas sensing solution for OEMs.
- Eliminates the need for calibration in most applications with Telaire's patented ABC Logic™ software. Lifetime calibration warranty (T6703 and T6713).
- A reliable sensor design based on 20 years of engineering and manufacturing expertise.
- Self calibrating dual channel models available for high CO<sub>2</sub> concentration and 24 hour occupancy (T6715).
- Flexible CO<sub>2</sub> sensor platform designed to interact with other microprocessor devices.
- Small compact design allowing simple product integration.
- Identical footprint and communication protocols for T6713, T6703 and T6715 allowing a single design to accommodate either single or dual channel options.



T6713 / T6703

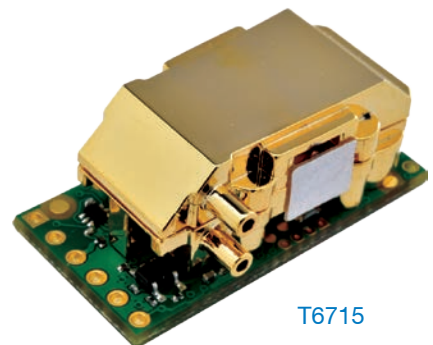

T6715

# Miniature CO<sub>2</sub> Modules for OEM Integration

## T6600 Series - Compact CO<sub>2</sub> Modules Designed to Integrate Into Existing Controls and Equipment

### T6613

The Telaire® 6613 CO<sub>2</sub> Module is designed to meet the volume, cost, and delivery expectations of Original Equipment Manufacturers (OEMs).

#### Features

- An affordable gas sensing solution for OEMs.
- A reliable sensor design based on 15 years of engineering and manufacturing expertise.
- Flexible CO<sub>2</sub> sensor platform designed to interact with other microprocessor devices.
- Eliminates the need for calibration in most applications with Telaire's patented ABC Logic™ software.
- Lifetime calibration warranty.

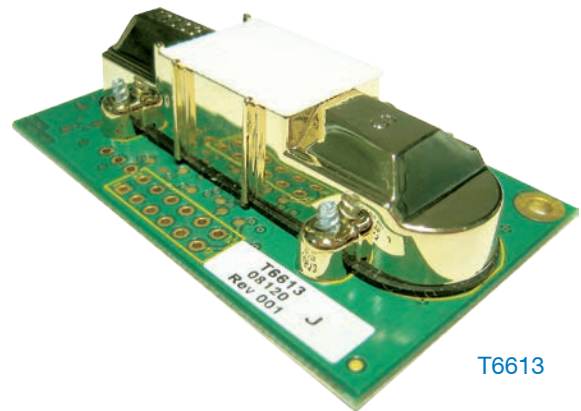

T6613

### T6615

The Telaire T6615 dual-channel CO<sub>2</sub> Module is designed to meet the volume, cost, and delivery expectations of Original Equipment Manufacturers (OEMs).

#### Features

- An affordable gas sensing solution for OEMs.
- A reliable sensor design based on 15 years of engineering and manufacturing expertise.
- Flexible CO<sub>2</sub> sensor platform designed to interact with other microprocessor devices.
- Dual-channel optical system and three-point calibration process for enhanced stability, accuracy and reliability.
- Designed for applications where ABC Logic cannot be used
- Sensor may be field calibrated
- Identical footprint for T6613 and T6615 allowing a single design to accommodate either single or dual channel options.

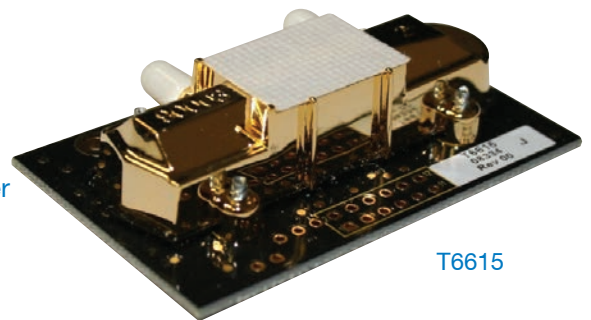

T6615

# SMART Dust Sensor for OEM Integration

## SM-PWM-01C

SM-PWM-01C is a dust sensor that detects the dust particle concentration in air by using optical sensing methods. An infrared light emitting diode (IR LED) and a photo-sensor are optically arranged in the device. The photo-sensor detects the reflected IR LED light by dust particles in air.

The SMART Dust Sensor can detect the small particles like cigarette smoke and it can distinguish small particles like smoke from large house dust by pulse pattern of signal output.

### Features

- Compact size, light weight  
(about W59x H46x D18 mm, 23g)
- PWM (pulse width modulation) output (Low pulse output)
- Able to distinguish small particles of cigarette smoke from large particles of house dust
- The Low pulse width is proportion to particle size and concentration
- Constant forced air convection flow by heater resistor in dust sensor
- Lead free and ROHS directive compliant
- Minimum particle size can be detected over  $1\mu\text{m}$   
(House dust size: avg  $20\mu\text{m}$ , yellow dust size: avg  $20\mu\text{m}$ , cigarette dust size: avg  $1\mu\text{m}$ )



SM-PWM-01C



# Relative Humidity Sensors for OEM Integration

We offer reliable, resistive and capacitive based sensors for multiple applications including harsh environments, instrumentation and HVAC control. The ChipCap 2® offers relative humidity and temperature measurements on a chip based platform enabling simple high volume manufacturing without the need for calibration.

ChipCap 2 offers the most advanced and cost effective humidity and temperature sensing solution for virtually any type of application. A capacitive polymer sensor chip and a CMOS integrated circuit with EEPROM are integrated into one embedded system in a reflow solderable SMD package. Individually calibrated and tested, ChipCap 2 performs at  $\pm 2\%$  from 20% to 80% RH ( $\pm 3\%$  over entire humidity range), and is simple and ready to use without further calibration or temperature compensation.

ChipCap 2 provides linear output signals in various interfaces to customer requirements:

- I<sup>2</sup>C interface
- PDM convertible to analog signal
- Alarm function for preset control at min/max humidity

## Features

- Fully Calibrated & Temperature Compensated
- Digital or Analog Output with Alarm Function
- Precision & Accuracy ( $\pm 2\%$  RH,  $\pm 0.3^\circ\text{C}$ , 14 bit )
- Free Operating Voltage (min 2.7V to max 5.5V)
- Low Current Consumption
- SMD Package for Automated Assembly
- Reliable in Harsh Environments



ChipCap 2

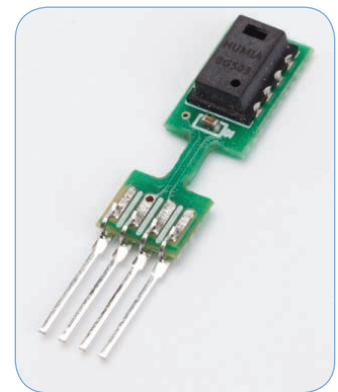

ChipCap 2 SIP



# Harsh Environment Sensors for OEM Integration

## Humidity and Temperature

The T9602 offers the most advanced and cost effective humidity and temperature sensing solution for virtually any type of application.

Based on our own capacitive polymer sensor chip and ASIC integrated into an easy mount OEM package.

Each sensor is individually calibrated and tested. The T9602 is simple and ready to use without further calibration or temperature compensation.

The T9602 provides linearized output signals in one of two interfaces to meet customer requirements.

- I<sup>2</sup>C interface
- PDM output convertible to an analogue signal
- Refer to Application guide section for more detailed interfacing information

## Features

- Fully calibrated and temperature compensated
- Water resistant (IP67 Certified)
- Hydrophilic filter protection
- Digital (I<sup>2</sup>C) or analogue output
- Optional wire length
- Precision & accuracy ( $\pm 2\%$  RH,  $\pm 0.3^\circ\text{C}$ , 14 bit)
- Low current consumption
- Reliable in Harsh Environments
- Different mounting options

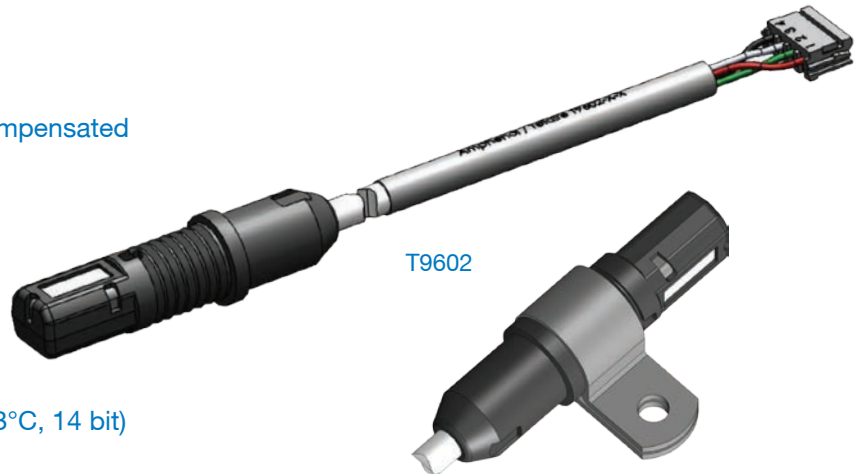



# Harsh Environment Sensors for OEM Integration

## CO<sub>2</sub>

The T3000 series is a range of sensors designed to meet the specific needs of customers who require measuring Carbon Dioxide in harsh or difficult environments. Based on a series of modules, the casing offers a number of combinations to meet the needs of range, supply voltage, and output type in a range of applications. Example applications include incubators, buses, refrigerators, subway stations, and railway carriages.

## Features

- Accurate carbon dioxide transmitter for HVAC control applications
- Easy mount with 2 external tabs.
- Rated up to IP67 (build dependent)
- Available with potting
- Different calibrations available up to 20% CO<sub>2</sub> concentration
- Analogue or digital output options



T3000



# Air Quality Engineering Development Kit

## Dust, CO<sub>2</sub> Humidity and Temperature Monitoring Demo Kit



```
TelaireSensors | Arduino 1.6.9
File Edit Sketch Tools Help
TelaireSensors OELCD.h SM-PWM-01C.h T6713.h T6713.h
#include "Wire.h"
#include <SPI.h>
#include <PinChangeInterrupt.h>

// Width Guide "-----"
#define SplashScreen "Telaire all, v1.0"
char ScreenHeader[] = " Amphenol Sensors";
char ScreenFooter[] = " Telaire Technology";
char DisplayUnit[] = "ppm";

#include <Adafruit_GFX.h>
#include <Adafruit_SSD1306.h>
#include "OELCD.h"
#include "T6713.h"
#include "SM-PWM-01C.h"

void setup()
{
  // !!!
}
```

Arduino Uno compatible solution that is adaptable by engineers to suit their needs.

## CO<sub>2</sub> Evaluation Kit

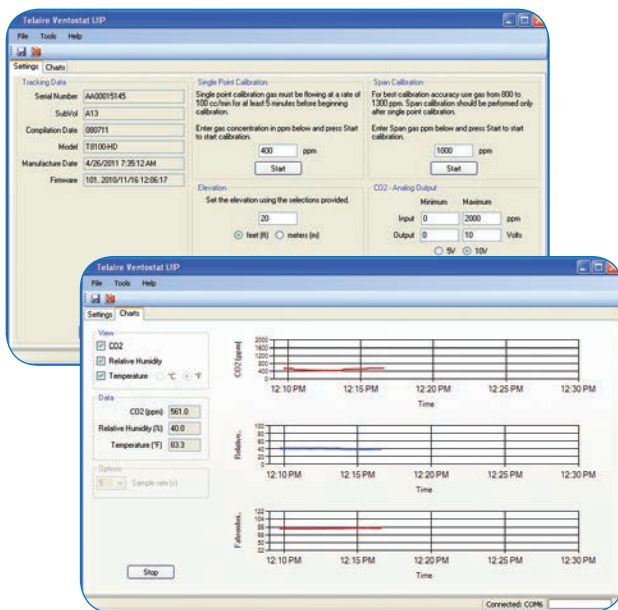

Carbon Dioxide Only kit for direct connection to laptop to observe and log CO<sub>2</sub> levels directly from the sensor module.

# Additional Sensor Technology

Amphenol Advanced Sensors is a world leader in advanced measurement and sensor-based technology solutions. We design and manufacture precision instruments and systems that measure temperature, pressure, humidity and gas concentration for customers around the world in the Healthcare, Transportation and Industrial Markets. We create value by providing critical information for real time decisions.

## Temperature - Thermometrics®

With more than 70 years of technology experience in the development, design and manufacture of high quality sensors, Thermometrics offers one of the most comprehensive ranges of temperature measurement and sensing products in the world today. Thermometrics' temperature technologies include high accuracy NTC thermistors, PTC heaters, IR and custom design capabilities globally. Thermometrics provides solutions to a wide range of temperature sensing challenges faced by the healthcare, automotive, industrial and consumer markets.



## Applications

- Intake air & Exhaust gas
- Coolant/transmission fluid
- Outside air & cabin temperature
- Catheter temperature
- Clinical Thermometers
- Neonatal
- Environmental control systems
- High voltage and short circuit protection
- Current limiting & surge suppression



## Pressure (MEMS) - NovaSensor®

Equipped with the most advanced design tools and cutting edge laboratories, NovaSensor is a leader in the design, model and fabrication of Microelectromechanical systems (MEMS). NovaSensor's MEMS sensor line includes state-of-the-art, high-performance and cost effective sensor solutions known for their accuracy, reliability and size. Our sensors offer best in class performance for applications in the healthcare, transportation and industrial markets.

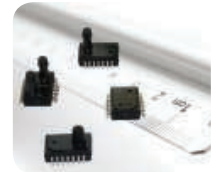

## Applications

- Automotive tire pressure
- Pneumatic controls
- Pressure switches and controllers
- Altimeters and barometers
- Portable gauges and manometers
- Catheter pressure
- Respiratory applications
- Sleep apnea
- Anesthesia
- Ventilation
- Disposable blood pressure

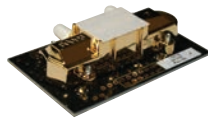

## Industry Leaders for Over 75 Years

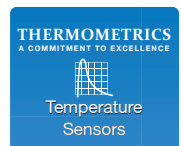
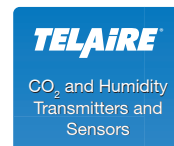
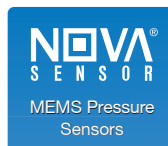



**Amphenol**  
Advanced Sensors

[www.telaire.com](http://www.telaire.com)

[www.amphenol-sensors.com](http://www.amphenol-sensors.com)

© 2017 Amphenol Corporation. All Rights Reserved. Specifications are subject to change without notice.

Other company names and product names used in this document are the registered trademarks of their respective owners.

AAS-BR-227B 01/2017